



PROK DEVICES PRIVATE LIMITED

B-80, 2nd & 3rd Floor, KSSIDC Industrial estate, 4th Main Road,
6th Block, Rajaji Nagar, Bengaluru -560010

Ph no: 080-41480777, 080-41157700, Email: enquiry@prokdvs.com,
www.prokdvs.com, www.prokdvs.in

ZERO SEQUENCE VOLTAGE/NEUTRAL DISPLACEMENT RELAY

Description

Prok Dvs an ISO 9001:2008 Company indigenously develops the power system protection relays and panel meters for power system. μ P based Zero sequence voltage relays are the state of the art design, to monitor and protect the costly equipments against unbalance voltages.

The Relay Continuously monitoring all the three phase Line to Line Voltages, if any abnormal condition persists in the system internal Relay activated with predetermined set value of definite time.

The Unit Displays Line to Line Voltages on LCD display, Healthy and Fault /Trip status Information through LED Display.

Features

- ❖ Accurate and reliable measurement .of residual voltage.
- ❖ Display of voltage magnitudes, using 8 character 2 line LCD
- ❖ User friendly Setting Parameters through key pad switch
- ❖ Wide range for Selection of residual voltage
- ❖ User configurable Definite tripping time (DMT)
- ❖ Fast tripping response(<500mS) when Phase and Neutral are Interchanged
- ❖ Industrial Rugged design in Din rail mounting as well as Panel Mounting.
- ❖ Healthy, Trip Status provided through LED visual indications.
- ❖ Auto Reset provided on Healthy voltage resumption

Application

- ❖ Voltage Unbalance/Earth fault protection
- ❖ Protection of Equipments/Components against Phase and Neutral Interchange

Technical Specifications

- ❖ **Rated System Voltage (Un):** 415V AC
- ❖ **Tripping characteristic:** DMT
- ❖ **Model:** DMPND
- ❖ **Voltage setting range:** (1-50) Volts in steps of 1V
- ❖ **Trip Time setting range:** (1-30) Sec In steps of 1Sec
- ❖ **Trip Time when Ph. & Neutral interchanged:** 500mS (Approx)
- ❖ **Output Relay:** 230VAC 5Amp /24VDC 5Amp
- ❖ **Auto Reset** provided on Healthy voltage resumption
- ❖ **AUX. Voltage:** 85-275V AC/DC Universal input, 50-60Hz
- ❖ **Display:** 8 chars 2 line LCD with backlit
- ❖ **LED:** For Visual indications of healthy & Trip status.
- ❖ **Mounting:** Flush mounting
- ❖ **Dimensions:** FLUSH MOUNTING: 96x96x65 mm (w x h x d) +/- 1mm Tolerance
DIN MOUNTING: 79x93x73 mm (l x h x b) +/- 1mm Tolerance

Setting procedure:

- 1) Connect aux. supply to the relay (50 to 500)V AC/DC

- 2) Press the  key for 3 seconds to make settings to the relay

- 3) Display Shows



Residual
Va Rly

- 4) Press  Key for 3Sec

- 5) Display changes to



Sel Un
415V

- 6) Press  key

- 7) Display Changes to



U0 020V
2V - 30V



Use  /  Key to select the value

Save the value by using the  Key.

- 8) Display changes to



DMT=003S
[1-30]S

Use  /  Key to set the desired operating time and operate

Set  key to save the selected value.

9) Display shows



Press  Key to Save the value.

10) Display shows



This completes the setting procedure for the relay.



Press the  to reset the relay

The moment 3Ph, line to line voltage is applied to the Relay starts measuring and Displaying the line voltages of the system.

CONNECTION DIAGRAM

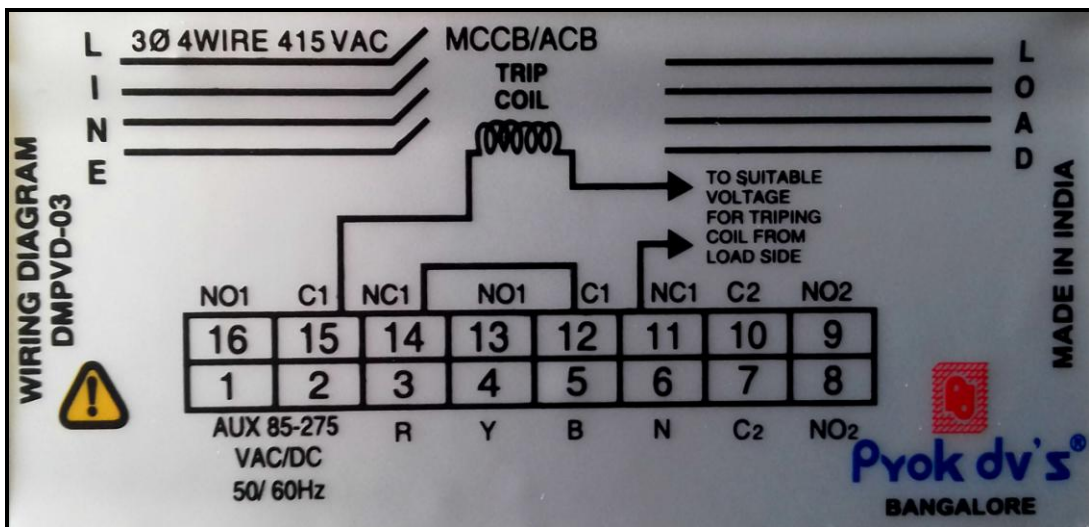

WIRING DIAGRAM

